

Our business is the development of software for the simulation of electronic and optoelectronic semiconductor nanodevices (e.g. nanotransistors, LEDs, solar cells, resonant tunneling diodes, quantum dots, quantum cascade lasers, HEMTs, infrared detectors).

Due to the continuing scaling of semiconductor electronics, quantum physical effects are gaining importance and confront the industry with fundamental challenges with respect to simulation and design.

Our unique selling proposition is an advanced physical method for the calculation of the quantum mechanical properties of an arbitrary combination of geometries and materials.

The nextnano software is not limited to certain types of devices and thus perfectly suited for both, currently existing devices and novel devices, like for instance protein sensors (biochips).

Our customers benefit from faster (time-to-market) and cheaper development of devices.

The nextnano GmbH is a spin-off from the Walter Schottky Institute of the Technische Universität München.

- Our customers benefit from
- + better understanding of device physics
 - + systematically improve and optimize devices
 - + less redesign cycles (optimum prototype)

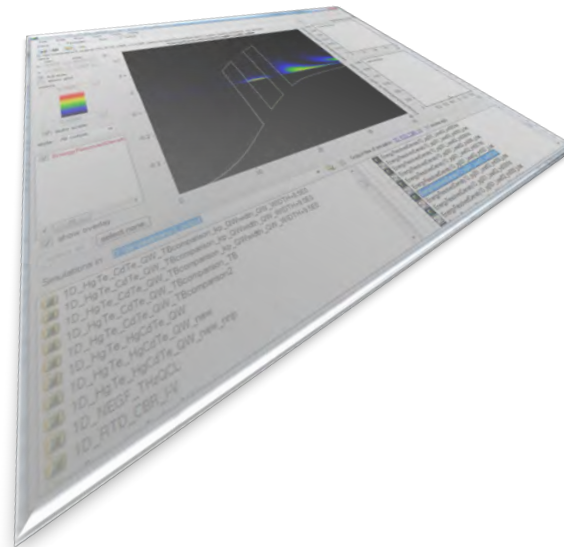

nextnano GmbH
 gate Garching Technologie- und Gründerzentrum
 Lichtenbergstr. 8
 85748 Garching b. München
 Germany

Contact
 Dr. Stefan Birner
 stefan.birner@nextnano.com
 +49 89 41 61 09 44

Software for the simulation of electronic and optoelectronic semiconductor nanodevices

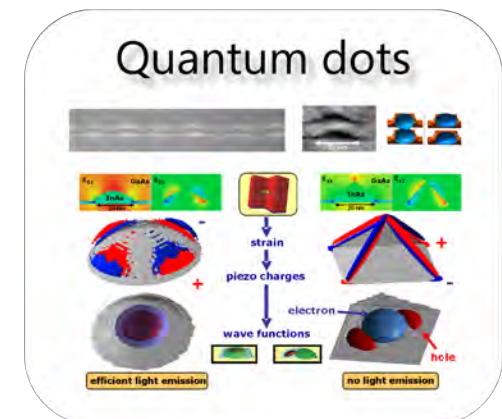
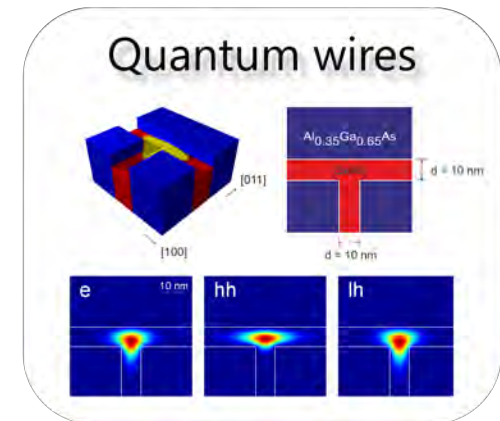

Features

- Schrödinger-Poisson-Current solver in 1D, 2D & 3D
- Effective-mass, 8-band k.p, quantum transport
- Strain, piezo & pyroelectricity
- Materials: group IV, III-V, II-VI (zinc blende, wurtzite)

Examples

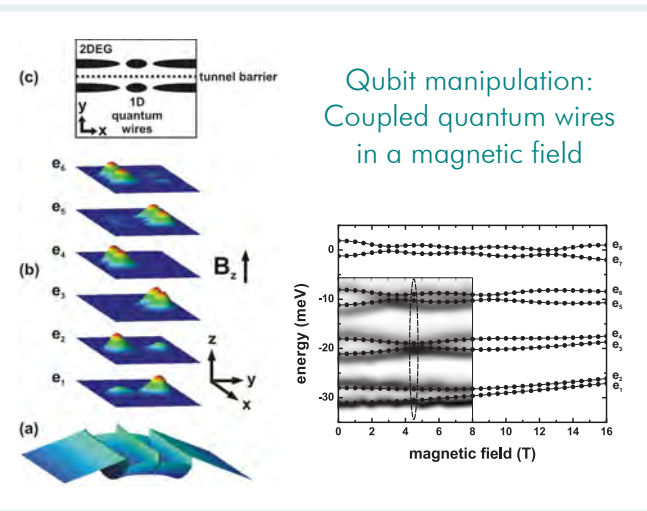
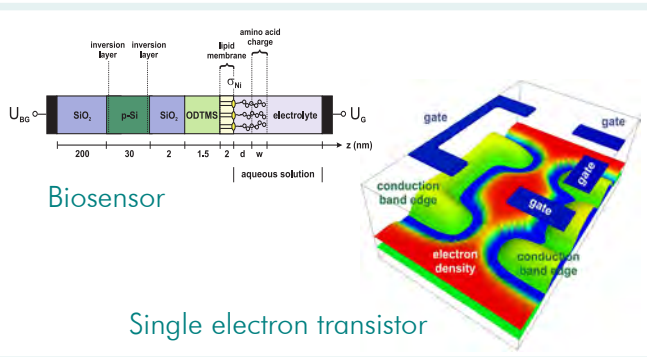

Quantum Cascade Lasers

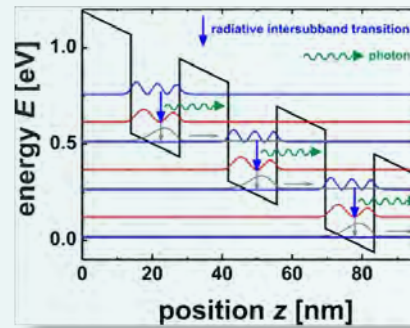

Operating principle

Photons are emitted via intersubband transitions. Electrons tunnel resonantly into the quantum well of the next cascade.

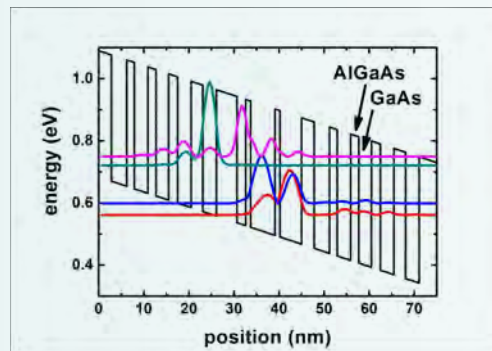

Electron wavefunctions

Each semiconductor layer is only a few atomic layers thin. The laser wavelength is designed by "Wavefunction engineering".

Quantum transport calculations using nonequilibrium Green's functions (NEGF)

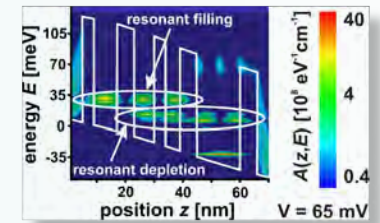

Local density of states

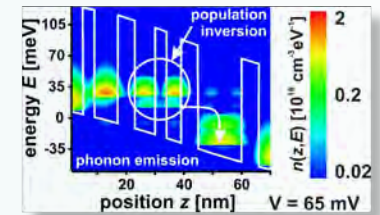

Electron density

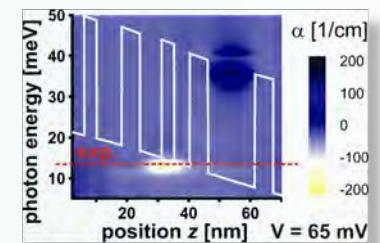

Gain

QCLs emit light in the mid-IR and THz regime. Application: Remote sensing of environmental gases